

IWAKI Magnetic Drive Pump

MD-6/10 type

Instruction Manual

 Read this manual before use of product

Thank you for selecting an Iwaki MD-6/10 type Magnetic Drive Pump. This instruction manual deals with "*Safety Instructions*", "*Outline*", "*Installation*", "*Operation*" and "*Maintenance*" sections.

Please read through this instruction manual to ensure the optimum performance, safety and service of your pump.

Contents

Safety Instructions	1
<i>Outline</i>	
1. Unpacking & Inspection	3
2. Operating principle	3
3. Specification & Identification code	4
4. Outer dimensions	5
5. Performance curves	6
6. Overview & Label	6
7. Part names & Structure	7
<i>Installation</i>	
1. Before installation	8
2. Installation/Piping/Electrical wiring	10
<i>Operation</i>	
1. Before operation	13
<i>Maintenance</i>	
1. Troubleshooting	15
2. Maintenance & Inspection	15



This instruction manual should be kept on hand by the end user for quick reference.

Contact us or your nearest dealer if you have any questions.



Important Instruction

For the Safe and Correct Handling of the Pump

- "Safety Instruction" section deals with important details about handling of the product. Before use, read this section carefully for the prevention of personnel injury or property damage.
- Observe the instructions accompanied with "WARNING" or "CAUTION" in this manual. These instructions are very important for protecting pump users from dangerous situations.
- The symbols on this instruction manual have the following meanings:

 WARNING	Nonobservance or misapplication of the contents of "Warning" section could lead to a serious accident which may result in death.
 CAUTION	Nonobservance or misapplication of the contents of "Caution" section could lead to a personal injury or damage to the product.

Types of Symbols

	Indicates a prohibited action or procedure. Inside or near this circle, a concrete and practical image of the activity to be avoided is depicted.
	Indicates an important action or procedure which must be performed or carried out without fail. Failure to follow the instructions herein can lead to malfunction or damage to the pump.

For exportation

Technology related to the use of goods in this instruction manual falls in the category of technology contained in the Foreign Exchange Order Attachment, which includes complementary export control of technology. Please be reminded that export license, which is issued by the Ministry of Economy, Trade, and Industry could be required, when this is exported or provided to someone even in Japan.

Safety Instructions

WARNING

- **Turn off the power.**

Risk of electrical shock. Dismantling/assembling the pump unit without turning off the power may cause an electrical shock. Before engaging in any maintenance or inspection work, be sure to turn off the pump and related devices.



Power off

- **Terminate operation.**

On sensing any abnormality, stop operation immediately and inspect/solve problems.



- **For specified application only**

The use of the pump in any application other than those clearly specified may result in injury or damage. Use the pump in a specified condition.



Prohibited

- **No dismantlement/modification**

Do not dismantle/modify the pump. We are not responsible for any accidents or damage due to modification.



No modification
No dismantlement

- **Wear protective clothing.**

Always wear protective clothing such as safety goggles and protective gloves during pipework or dismantlement.



Wear protectors

CAUTION

- **Restriction on operator**

The pump should be handled by a qualified person with a full understanding.



Prohibited

- **Specified power only**

Do not apply any power other than the specified one on the nameplate. Otherwise damage or fire may result.



Prohibited

- **Do not wet the pump.**

If a liquid spills over electric parts or wires, a fire or electrical shock may result. Install the pump in a place free from liquid spillage.



Prohibited

- **Ventilation**

Poisoning may result when handling a toxic or odorous liquid. Keep good ventilation in a work area.



Caution

- **Countermeasure against efflux**

Take a protective measure against the accidental efflux caused by pump or pipe breakage.



Caution

- **Damaged pumps.**

Do not use any damaged pump. Using a damaged pump may lead to an electric leak or shock.



Prohibited

Safety Instructions

CAUTION

- **Do not place the pump close to water.**
The pump is not dust-/water-proof construction. The use of the pump in a humid place or a place where the pump can get wet may result in electrical shock or short-circuit.
- **Do not run pump dry.**
If the pump runs without a liquid, the pump is damaged by friction heat.
- **Do not damage the power cable.**
Risk of fire or electrical shock. Do not scratch, modify, or pull the power cable. The cable can also be damaged when it is heated or loaded with a heavy thing.
- **Do not cover the motor during operation.**
Or heats builds up and fire or mechanical failure may result.
- **Earthing**
Risk of electrical shock. Always earth the pump.
- **Install an earth leakage breaker.**
An electrical failure of the pump may adversely affect related devices. Purchase and install an earth leakage breaker separately.
- **Power cable is not replaceable.**
Do not use any damaged power cable for the prevention of a fire or electrical shock. The cable is not replaceable, so that the whole pump unit needs to be replaced when the cable is damaged.



Prohibited



Prohibited



Caution



Earthing



Electrical shock



Caution

CAUTION

- **Limited operating site and storage**
Do not install or store the pump in the following places where...
 1. Ambient temperature is beyond the range of 0-40°C.
 2. Under a flammable/corrosive atmosphere.
- **Do not drain a harmful chemical liquid directly on the ground or the floor.**
Use a container.
- **Disposal of the used pump**
Dispose of any used or damaged pump in accordance with relevant regulations. Consult a licensed industrial waste products disposing company.
- **Static electricity**
When low electric conductivity liquids such as ultra-pure water and fluor inactive liquid (e.g. Fluorinert™) are handled, the static electricity may generate in the pump and may cause static discharge. Take counter-measures to remove the static electricity.
- **Do no use a damaged pump.**
Using a damaged controller could lead to an electric leak or shock.
- **Wear part replacement**
Follow instructions in this manual for wear part replacement. Do not dismantle the pump beyond the extent of the instructions.



Prohibited



Prohibited



Prohibited



Outline

Before use, check the specification, limitation and hazardous nature of the pump.

1. Unpacking & Inspection

On unpacking the product, check the following points. If you find any problems, contact your nearest distributor.

1. Check the information on the nameplate such as model, discharge capacity, discharge head and voltage to see that the product is delivered as per order.

Iwaki Magnet Pump	
MODEL	
MAX.CAPACITY	ℓ/min
MAX.HEAD	m
VOLTAGE	V
SPEED	rpm
FREQUENCY	Hz
POWER CONSUMPTION	W
THERMALLY PROTECTED INDOOR USE ONLY	
Year	
DO NOT RUN PUMP DRY	
MFG.No.	
IWAKI CO.,LTD. MADE IN JAPAN	
6-6,Kanda-Sudacho 2-chome Chiyodaku Tokyo Japan	
2P-407499	
CE	

2. Check for transit damage, deformation, and loose bolts.

2. Operating principle

The MD-6 & -10 are magnetic drive centrifugal pumps. The magnetic force of the motor drives the impeller magnet and rotates the impeller in the pump chamber, where a liquid is transferred from the inlet to outlet.

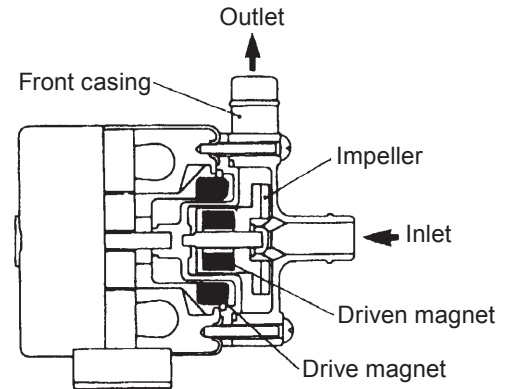

3. Specification & Identification code

Identification code

Shaded-pole motor

MD - 6Z - 230GS

a b

- a. Series model MD-6: Low flow
 MD-6Z: High head
 MD-10: High flow
- b. Power voltage 230V (50/60Hz)

Capacitor motor

MD - 6Z - 220 E N 01

a b c d e

- a. Series model MD-6: Low flow
 MD-6Z: High head
 MD-10: High flow
- b. Power voltage 220: 220/240V (50/60Hz)
- c. O ring material E: EPDM
 No code: FKM
- d. Motor N: Capacitor motor
- e. Special version No code: Standard
 01-99: Special design

Specification

50/60Hz

Model	Pump connection bore (mm)		Max flow (L/min)	Max head (m)	Norm flow (m-L/min)	Max SG	Motor		Mass (kg)	Max operating pressure (MPa)
	Inlet	Outlet					Power (V)	Rated output (W)		
MD-6	14	14	8/9	1.0/1.4	0.8-2.8/ 0.8-5	1.2	220/240	3	0.8	0.02
MD-6-N								5	0.9	
MD-6Z			5.5/6.0	2.1/2.7	1.5-3.2/ 1.5-4.5	1.1		3	0.8	0.04
MD-6Z-N								5	0.9	
MD-10								11/12	1.5/2.1	
MD-10-N			5	0.9						

NOTE:

- a. Performance data is based on pumping of clear water at ambient temperature.
- b. The maximum flow is obtained at zero discharge head, and the maximum head is obtained at the maximum pressure.
- c. The maximum viscosity is up to 30mPa*s (at SG 1.0).
- d. Allowable liquid temperature is as follows.

Liquid temp.	Model
0-80C°	MD-6/MD-6-N/MD-6Z/MD-6Z-N/MD-10-N
0-75C°	MD-10

- *Note that the liquid temperature is based on pumping clean water and it changes with liquid property and operating conditions.
- e. Non freezing
 - f. The maximum specific gravity is obtained at or near the maximum flow. Note that the limitation varies with a duty point, ambient or liquid viscosity.

g. Motor type

Single-phase shaded-pole motor with thermal protection
or Single-phase capacitor-run induction motor with thermal protection

*The pump stops when the motor temperature becomes extremely high due to ambient or liquid temperature rise or overload operation. The pump resumes operation after temperature falls to a normal.

⚠ CAUTION

If pump stops frequently, turn off power and check for impeller damage or clogging. See “Troubleshooting” on page 15.

4. Outer dimensions

• MD-6 · 6Z · 10

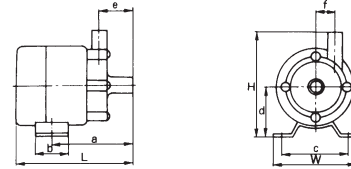

Model	W	H	L	a	b	c	d	e	f
MD-6, 6Z·10	74	92	105	73	30	60	45	31	17

• MD-6-N · 6Z-N · 10-N

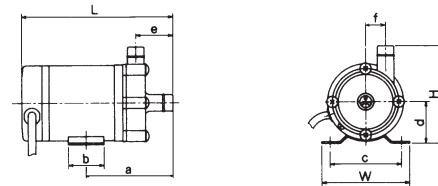

Model	W	H	L	a	b	c	d	e	f
MD-6-N, 6Z-N·10-N	74	82	129	73	30	60	35	31	17

5. Performance curves

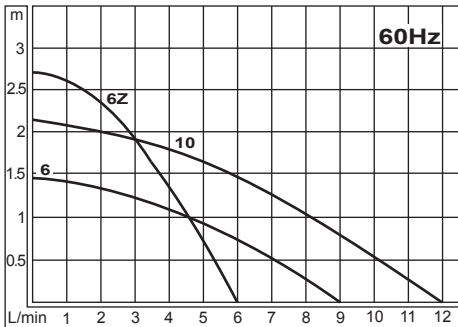
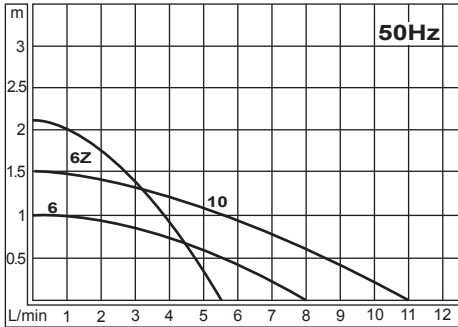

6. Overview & Label

• • • Pump unit (Liquid feeding unit)
Not capable of self-priming. Always prime the pump before operation.

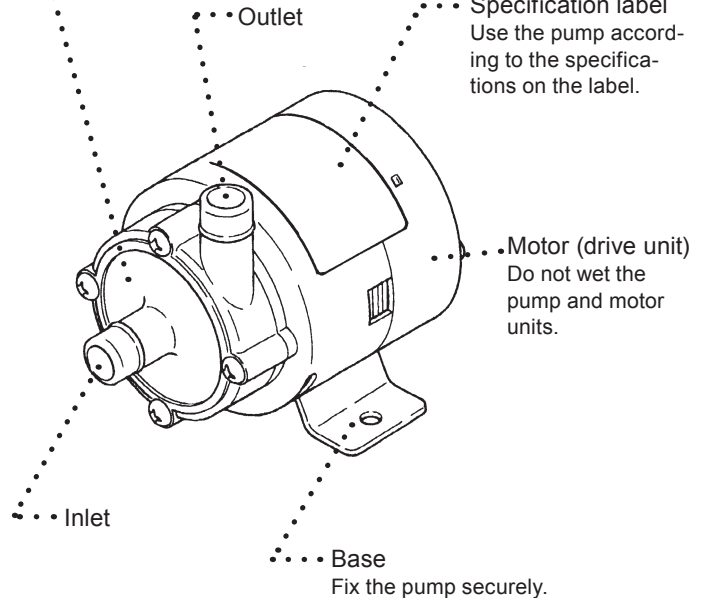

7. Part names & Structure

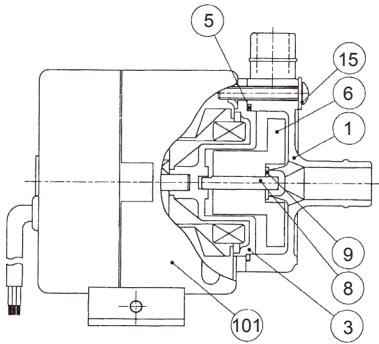

No.	Part names	Q'ty	Materials	Remarks
1	Front casing	1	GFRPP	
3	Rear casing	1		
5	O ring	1	FKM, EPDM	AS568-031
6	Impeller	1	GFRPP	
8	Spindle	1	Alumina ceramic	
9	Thrust ring	1	UHMW-PE	
15	Machine screw	4	Stainless steel	M4×28 with PW/SW
101	Motor	1		

Installation

1. Before Installation

Read through this instruction manual before use. Carry out installation work with a full understanding.

WARNING

- Risk of electrical shock. Turn off the power when the pump or its electrical parts get wet by mistake. Do not touch directly.
- No fire
Keep the pump away from dangerous or flammable object.
- The pump is not designed for the use in food or beverage industries. Contact us for detail.

CAUTION

- A strong magnet is inside the pump. Do not bring a watch or floppy disk which may be adversely affected by a magnetic force.
- Do not run pump dry. If the pump runs without a liquid, friction heat damages the pump.

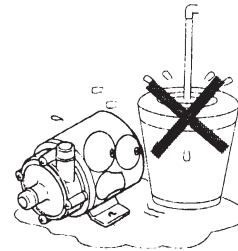
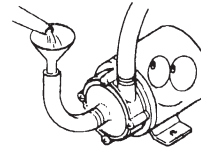

- Dropping or subjecting the pump to strong impact, failure may result.
Handle the pump with care.

- The pump is not capable of self-priming. Always prime the pump before operation.

- Do not get the motor wet. The pump is not dust-/water-proof or rust-proof construction.

- Risk of fire or electrical shock. Do not scratch, modify, twist or pull the power cable. The cable can also be damaged when it is heated or loaded with a heavy thing. Stop operation and contact us if the power cable is damaged.

Installation

- Banned solutions

- A liquid that significantly swells the used plastics
- Paraffinic hydrocarbons such as gasoline and kerosene
- Halogenated hydrocarbons such as trichloroethylene and carbon tetrachloride
- Ether and low-grade ester
- Slurry (Never use slurry, which wears out the pump bearings.)

 **CAUTION**

- Do not install or store the pump in the following places where...

1. Ambient temperature exceeds 40°C or falls below 0°C.
2. In a dusty/humid place.
3. Under direct sunlight or wind & rain.

- A strong magnet is inside the pump. Do not use the pump with any liquid which contains metals such as iron and nickel.

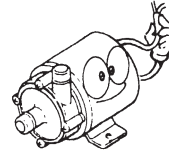

- For risk reduction, purchase and install the fuse.

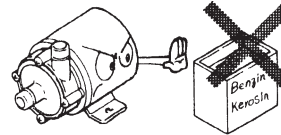
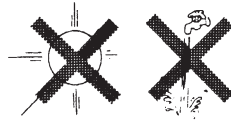

- Do not use solvents such as benzene, alcohol, thinner for maintenance or cleaning, otherwise the coating discolours or comes off.

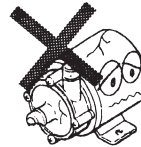

- Do not use any damaged pump. Using a damaged pump may lead to an electric leak or shock.

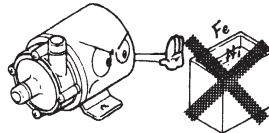

- An electrical failure of the pump may adversely affect related devices. Purchase and install an earth leakage breaker separately.

Installation

2. Installation/ Piping/ Electrical wiring

Stop working upon sensing danger or abnormality in work.

2.1 Installation

1. Installation location

Select a convenient place for maintenance and inspection.

- Install the pump in a clear and flat place.
- The pump should always be free from liquid spillage.
- Keep good ventilation, taking account of the self-heating of pump.

2. Mounting position

This pump is not capable of self-priming. The pump should be installed lower than the suction liquid level.

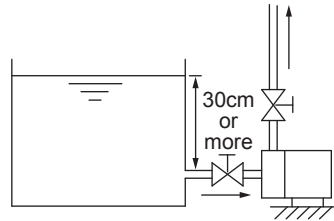

Direct the outlet upward

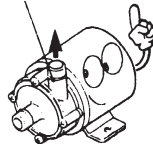

3. Outlet direction

Always direct the outlet upward or entrained air can not be expelled.

4. Pump fixation

Secure the pump by fixing the base. Do not install the pump vertically.

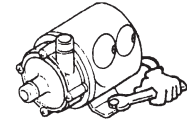

5. Hose preparation

Flat the tube end before tubing.

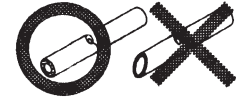

2.2 Piping

1. In order to minimize piping resistance, have the piping shortest with the minimum bends. For the prevention of cavitation, have the suction piping bore wide as much as possible.

2. Use a corrosion-/pressure-resistant vinyl tube, otherwise the suction hose can be crushed by the suction force (especially for hot liquid). A braided tube or teflon tube is recommended.

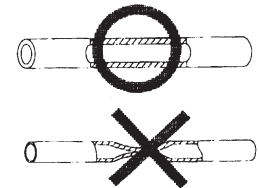

Installation

3. Do not allow piping system to weigh heavily on the plastic inlet or outlet, otherwise the plastic parts may deform and result in failure.

4. Be sure the connection between the pump, joints and pipes are correctly sealed.

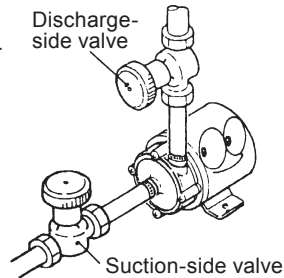

5. Install valves on both discharge and suction lines.

- Suction-side valve:
For easy pump removal and maintenance.
- Discharge-side valve:
For adjustment of the flow rate and discharge head.

6. Insert the tube into inlet or outlet as far as it will go.

CAUTION

Air is entrained if a suction tube connection is not secured. This may cause performance reduction, dry running and impeller seizing.

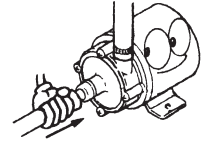

7. Use a clamp to secure the tube connection and eliminate the possibility of leakage. Do not use a wire instead of the clamp.

CAUTION

The inlet and outlet are made of plastics. Do not tighten the clamp too much.

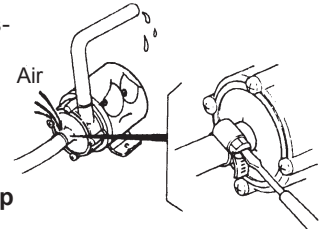

Installation

2.3 Electrical wiring

Electrical wiring must be done by qualified person who has a full knowledge of safety. We are not responsible for the injury or damage accident due to nonobservance of this warning. Contact us or your nearest distributor for wiring as necessary.

■ Before wiring

1. Confirm that the power is disconnected before work.
2. Wiring work should be done in accordance with electric work requirements. Use the recommended wiring accessories and follow electrical installation requirements.
3. Apply the specified power voltage. See the spec label.
4. The pump doesn't have the ON-OFF switch. The pump starts as the power cable is plugged in.
5. Earth the pump by an earthing wire.
6. When a leakage breaker is used.
Always solve the root cause when a leakage breaker operates. Replace the fuse and resume operation. Be sure to unplug the pump before investigation.

■ Connection diagram

● MD-6, 6Z and 10 types

● MD-6-N, 6Z-N and 10-N types

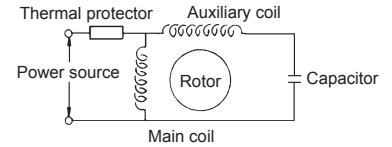
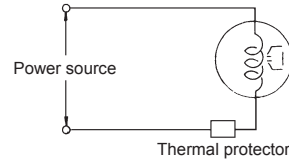

■ Rated current & Starting current

Model	Rated current	Starting current
MD-6	0.15A/0.14A	0.23A/0.2A
MD-6-N	0.07A/0.07A	0.1A/0.1A
MD-6Z	0.30A/0.30A	0.35A/0.34A
MD-6Z-N	0.08A/0.08A	0.1A/0.1A
MD-10	0.30A/0.30A	0.35A/0.34A
MD-10-N	0.08A/0.09A	0.1A/0.1A

Operation

1. Before operation

 **CAUTION**

- Before operating the pump, check that the pump is securely fixed.
- If foreign matters enter the pump, turn off the power and remove them, otherwise failure or malfunction may result.
- Do not run pump dry. If the pump runs without a liquid, the pump is damaged by friction heat.

1. Before operation, check that the pump is firmly installed in piping via the inlet and outlet.
2. Do not run the pump with a discharge/suction valve closed.
3. Do not open the discharge valve or suction valve at once, otherwise the magnetic coupling may disconnect (In this case turn off the power.).

■ Operation

After installation, piping and wiring work are completed, operate the pump in accordance with the following procedures.

No.	Procedure	Points to be checked
1	Check piping, wiring and voltage.	<ul style="list-style-type: none"> • See "2.2 Piping" and "2.3 Electrical wiring" sections. • Check the spec label to see if the power supply voltage is correct.
2	Open or close a valve.	<ul style="list-style-type: none"> • Fully open a suction-side valve. • Fully close a discharge-side valve.
3	Prime the pump chamber.	<ul style="list-style-type: none"> • Prime the pump with liquid (In suction lift application).
4	Supply power to the pump.	<ul style="list-style-type: none"> • Check the item 1, 2 and 3. Then turn on power and start the pump.
5	Adjust discharge capacity & discharge head to specified level.	<p>Open a discharge-side valve gradually till the flow and head reach a specified level. <u>Do not open or close the valve at once.</u></p> <p>Note: Do not keep the discharge-side valve closed more than 1 minute.</p> <p>Note: Check that the pump transfers a liquid without trouble. If there is a problem, turn off the power immediately and solve the cause. See "Troubleshooting" section.</p>

Operation

No.	Procedure	Points to be checked
6	Points to be checked during operation	<ul style="list-style-type: none">• Do not allow foreign matters to enter the pump. Foreign matters may cause impeller to be locked, hindering liquid circulation. In this case turn off power immediately (Contact us).• Turn off power when the leakage breaker operates. Investigate the root cause on the Trouble shooting section of page 15.

■ Shutdown

No.	Procedure	Description
1	Close a discharge-side valve.	Close the discharge-side valve gradually. Do not use the solenoid valve.
2	Turn off power.	Check if the motor stops rotating smoothly as turning off power. If it is not smooth, check the motor. Contact us for detail.

■ Before a long period of storage

Remove the liquid from the pump before it is stored for a long time. In addition, run the pump with clean water for 5 minutes every 3 months to prevent the motor bearing from being stuck.

Maintenance

1. Trouble shooting

Handling of the pump, maintenance and inspection should be carried out within this instruction manual. Do not handle the pump beyond the descriptions in this manual.

We are not responsible for any personal injury or property damage due to nonobservance of this warning. Contact us or your nearest distributor as necessary.

Phenomenon	The pump does not run.	Poor discharge head	Overcurrent	Noise and vibration problem	Leakage	Measure
Wrong wiring	<input type="radio"/>		<input type="radio"/>			Inspect wiring. Rewire as necessary.
Motor failure	<input type="radio"/>		<input type="radio"/>			Contact us.
Air is trapped.		<input type="radio"/>		<input type="radio"/>		Eliminate air.
Air suction from the inlet		<input type="radio"/>				Check suction piping.
Dry running		<input type="radio"/>	<input type="radio"/>	<input type="radio"/>		Check conditions before operation.
Too high SG or viscosity	<input type="radio"/>	<input type="radio"/>	<input type="radio"/>			Replace with suitable pump.
Impeller magnet hits the rear casing		<input type="radio"/>	<input type="radio"/>	<input type="radio"/>		Contact us.
Impeller is damaged.	<input type="radio"/>	<input type="radio"/>	<input type="radio"/>	<input type="radio"/>		Contact us.
Foreign matters on the impeller.		<input type="radio"/>	<input type="radio"/>	<input type="radio"/>		Contact us.
O ring is damaged					<input type="radio"/>	Contact us
Pump head mounting screws are loose.		<input type="radio"/>			<input type="radio"/>	Tighten the mounting screws.

2. Maintenance & Inspection

■ Retightening

After a long period of operation or storage, the pump head mounting screws may be loose. Tighten the mounting screws as necessary, but then do not deform the plastic pump head.

■ Daily inspection

Always check for abnormality in vibration, noise, current value, and discharge capacity. Stop operation on sensing any abnormality. And solve problems on the trouble shooting section.

Maintenance

■ Disassembling and assembling

Do not dismantle the pump beyond the extent in this manual. We are not responsible for any person injury or property damage caused by nonobservance of this instruction.

⚠ CAUTION

Before dismantling the pump, be sure to completely remove liquid from the pump. Do not wet the motor.

1. Remove the four screws (15).
2. Remove the front casing (1).
3. Remove the impeller (6) together with the thrust ring (9), holding the rear casing. Be careful not to lose the thrust ring.
4. Remove O ring (5) from the rear casing.
5. Pull out spindle (8), holding the rear casing.

⚠ CAUTION

Protect the motor from dust or liquid during dismantlement.

⚠ CAUTION

Do not remove the rear casing from the motor. We do not take any responsibility for damage caused by nonobservance.

■ Wear parts

- Replace wear parts before the end of estimated life.
- The estimated life is calculated based on the continuous operation with ambient temperature clean water and changes with operating conditions.
- We are not responsible for damage due to use of slurry.
- Replace O ring with new one every time dismantling the pump despite of the estimated life.

No.	Parts	Estimated life
5	O ring	10,000hours
6	Impeller	
8	Spindle	
9	Thrust ring	
101	Motor	

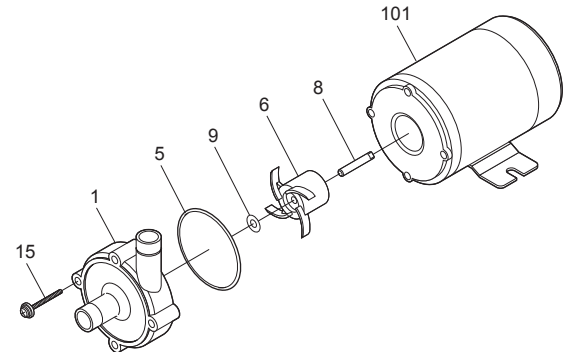

Maintenance

■ Drainage

 WARNING
--

- | |
|--|
| <ul style="list-style-type: none">● Turn off power before work.● Always wear protective clothing such as safety goggles and protective gloves during pipework or dismantlement. |
|--|

 CAUTION
--

- | |
|--|
| <ul style="list-style-type: none">● Do not get wet with chemical when removing the hose. Do not wet the motor or electric parts.● Do not drain a harmful chemical liquid directly on the ground or the floor. Always use a container. |
|--|

■ Procedure

1. Turn off power. Make sure no one turns on the power while working on the pump.
2. Close the discharge- and suction-side valves fully.
3. Place a container under the pump and loosen the hose clamp. Pull out hoses from the inlet and outlet. Be careful not to get wet with chemicals.
4. Unfix and take out the pump.
5. Drain residual chemicals through the inlet. Do not drain a harmful chemical liquid directly on the ground or the floor. Use a container.



IWAKI CO.,LTD. 6-6 Kanda-Sudacho 2-chome Chiyoda-ku Tokyo 101-8558 Japan
 TEL:(81)3 3254 2935 FAX:3 3252 8892(<http://www.iwakupumps.jp>)

()Country codes

Australia	IWAKI Pumps Australia Pty. Ltd.	TEL: (61)2 9899 2411	FAX: 2 9899 2421	Italy	IWAKI Italia S.R.L.	TEL: (39)02 990 3931	FAX: 02 990 42888
Austria	IWAKI (Austria) GmbH	TEL: (43)2236 33469	FAX: 2236 33469	Korea	IWAKI Korea Co.,Ltd.	TEL: (82)2 2630 4800	FAX: 2 2630 4801
Belgium	IWAKI Belgium n.v.	TEL: (32)1367 0200	FAX: 1367 2030	Malaysia	IWAKIm Sdn. Bhd.	TEL: (60)3 7803 8807	FAX: 3 7803 4800
China	IWAKI Pumps (Shanghai) Co., Ltd.	TEL: (86)21 6272 7502	FAX: 21 6272 6929	Norway	IWAKI Norge AS	TEL: (47)66 81 1660	FAX: 66 81 1661
China	IWAKI Pumps (Guandong) Co., Ltd.	TEL: (86)750 3866228	FAX: 750 3866278	Singapore	IWAKI Singapore Pte. Ltd.	TEL: (65)6316 2028	FAX: 6316 3221
China	GFTZIWAKI Engineering & Trading (Guangzhou)	TEL: (86)20 8435 0603	FAX: 20 8435 9181	Spain	IWAKI Iberica Pumps, S.A.	TEL: (34)943 630030	FAX: 943 628799
China	GFTZIWAKI Engineering & Trading (Beijing)	TEL: (86)10 6442 7713	FAX: 10 6442 7712	Sweden	IWAKI Sverige AB	TEL: (46)8 511 72900	FAX: 8 511 72922
Denmark	IWAKI Nordic A/S	TEL: (45)48 24 2345	FAX: 48 24 2346	Switzerland	IWAKI (Schweiz) AG	TEL: (41)26 674 9300	FAX: 26 674 9302
Finland	IWAKI Suomi Oy	TEL: (358)9 2745810	FAX: 9 2742715	Taiwan	IWAKI Pumps Taiwan Co., Ltd.	TEL: (886)2 8227 6900	FAX: 2 8227 6818
France	IWAKI France S.A.	TEL: (33)1 69 63 33 70	FAX: 1 64 49 92 73	Taiwan	IWAKI Pumps Taiwan Co.,Ltd.(Hsin-chu)	TEL: (886)3 573 5797	FAX: (886)3 573 5798
Germany	IWAKI EUROPE GmbH	TEL: (49)2154 9254 0	FAX: 2154 9254 48	Thailand	IWAKI (Thailand) Co.,Ltd.	TEL: (66)2 322 2471	FAX: 2 322 2477
Holland	IWAKI EUROPE NL Branch	TEL: (31)547 293 160	FAX: 547 292 332	U.K.	IWAKI Pumps (UK) LTD.	TEL: (44)1743 231363	FAX: 1743 366607
Hong Kong	IWAKI Pumps Co., Ltd.	TEL: (852)2 607 1168	FAX: 2 607 1000	U.S.A.	IWAKI AMERICA Inc.	TEL: (1)508 429 1440	FAX: 508 429 1386
Indonesia	IWAKI Singapore (Indonesia Branch)	TEL: (62)21 690 6606	FAX: 21 690 6612	Vietnam	IWAKI Pumps Vietnam Co.,Ltd.	TEL: (84)613 933456	FAX: 613 933399